

## Parts List

**!** **AVOID** use of sunshade when driving vision is impaired

### Sunshades



x 2

or



x 2

or

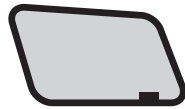

x 2

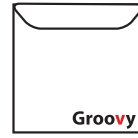

x 1

Nylon bag

A) Front door shades

B) Rear door shades

C) Rear panel shades  
(MPV/SUV models only)

### Clips

(CK-41)

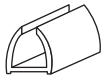

x 10

### Cleaning set



Alcohol Pad

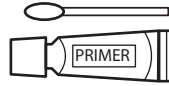

Primer

**!** \*Apply primer **ONLY** if surface has been treated or polished

## Recommended Clip Installation Positions

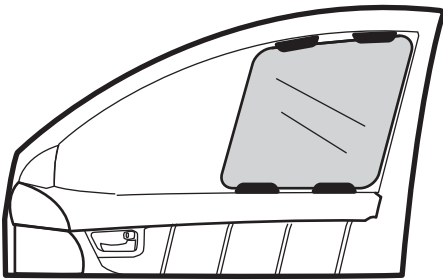

Front Door

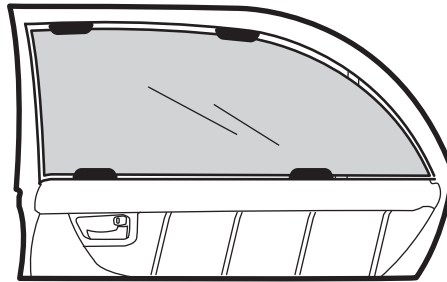

Rear Door

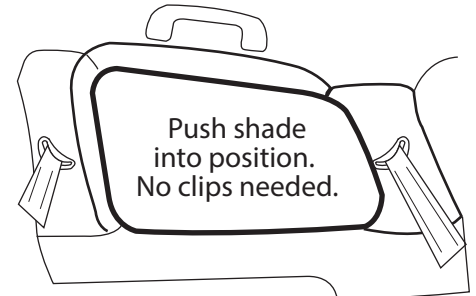

3rd row seat  
(MPV/SUV models only)

## Installation Guide

**1** Wind down window halfway. Clean installation points with alcohol pad. Wait - 30 seconds.

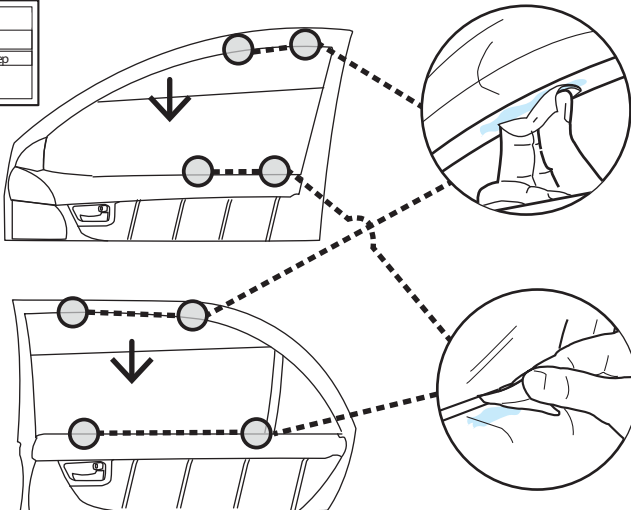

**2** Apply primer at installation points. Wait - 30 seconds. The purpose is to increase adhesive efficiency between surface and tape.

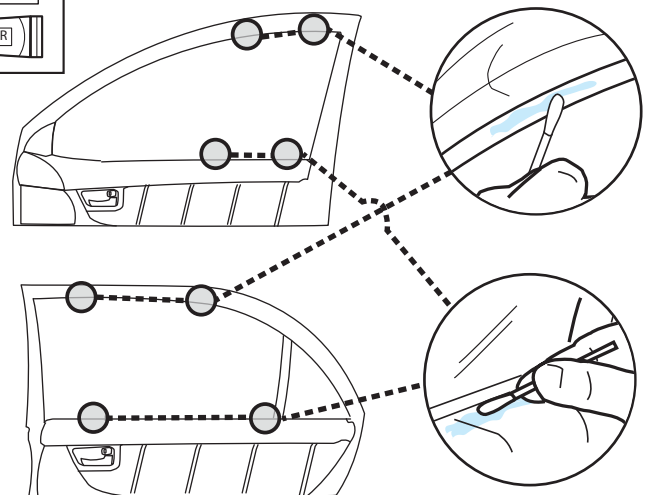
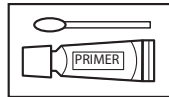

**!** Apply primer **ONLY** if surface has been treated or polished.

**3** Attached all clips

Top

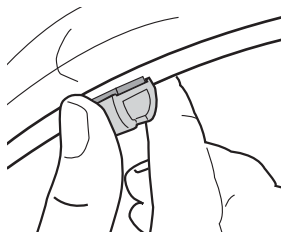

Bottom

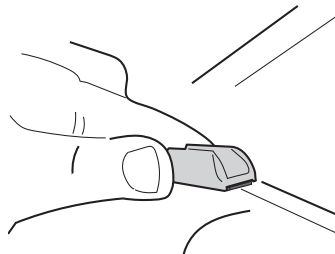

**4** Repeat process no.1- 3 for all position

## Sunshade Installation Guide

**!** **AVOID** use of sunshade when driving vision is impaired

### Front Door

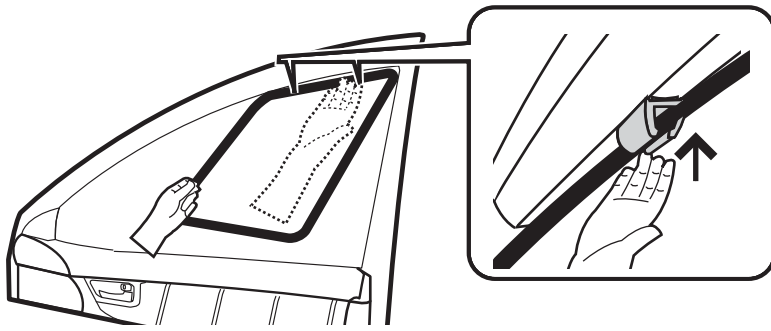

**1** Insert top section of the sunshade into clips

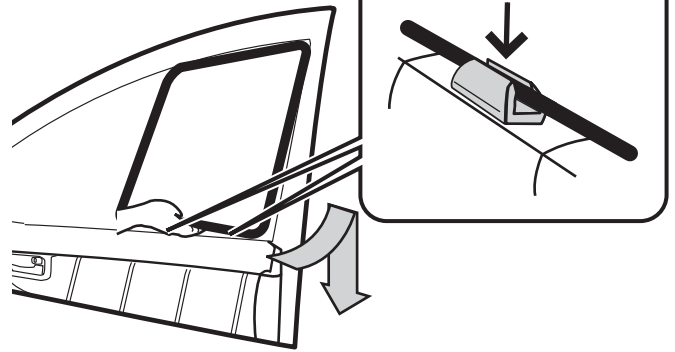

**2** Insert bottom section of the sunshade into bottom side of door panel **A**

### Rear Door

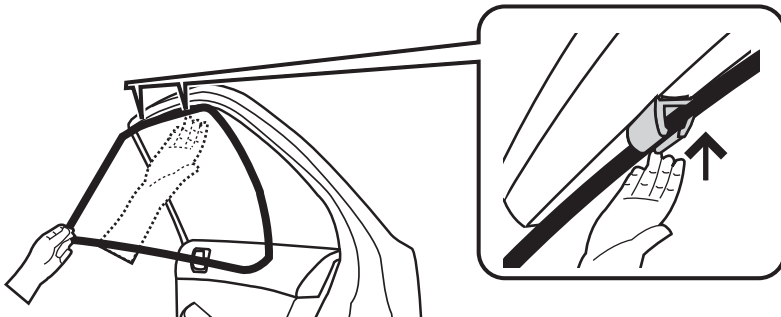

**1** Insert top section of the sunshade into clips

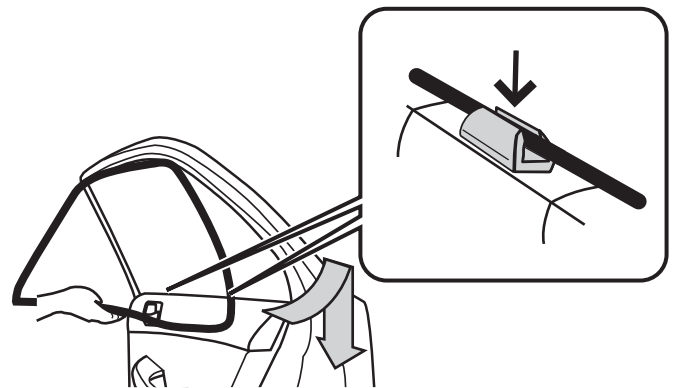

**2** Insert bottom section of the sunshade into clips

### 3rd row window

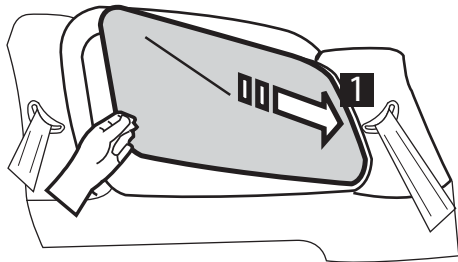

Insert rear corner of shade into panel **1**

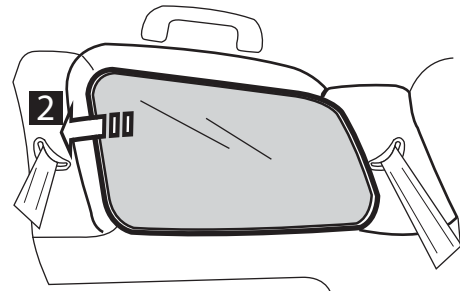

Insert front corner of shade into panel **2**

### Collapse

Step 1

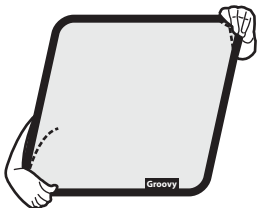

Step 2

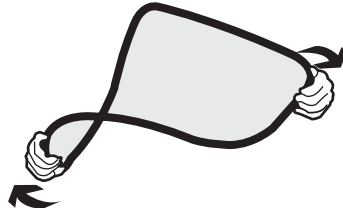

Step 3

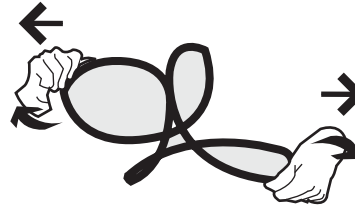

Step 4

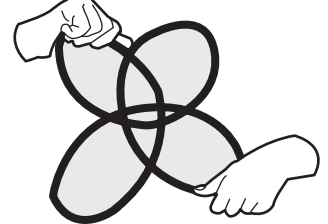

Remark :-

- Apply primer only if surface has been treated or polished.
- Adhesive tape have the highest efficiency for one time use only.
- Adhesive efficiency will be increased 90 % within 24 hours and will be the highest efficiency within 72 hours.
- Normally, spring frame may be distorted slightly.
- Please avoid use of sunshade when driving vision is impaired.